

STAND IN SOLIDARITY

DONATE

FOR CARBON NEUTRAL NITK

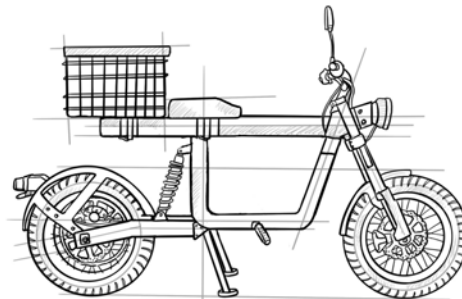

VidhYug

E - Scooter 2.2 Series Eco - System

EXCLUSIVE FOR RE-OFFICE

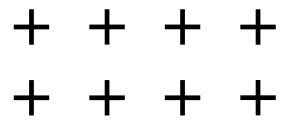

AN EARNEST PLEA TO NITK ALUMNI - MUMBAI CHAPTER

"An investment in knowledge pays the best dividends" - Benjamin Franklin

No one knows the meaning of the above quote better than NITK Alumni. Alumni represent the success of any educational institution and it is also in the hands of the alumni to lift up the institution when the need arises. We at Centre for System Design, NITK Surathkal earnestly request all of you to come forward and generously contribute for this cause. Your donations will go a long way in bringing glory to NITK. The donors will be made a part of the project review committee consisting of Professors from the NITK fraternity and representatives from the alumni association. Donors will have a say in the progress of the project. It is our assurance to maintain transparency in all our transactions and the outcome of this project will be updated on social media and YouTube from time to time.

ACCOMPLISHED TO DATE

E - SCOOTER

VidhYug 2.0

EXCLUSIVELY FOR RE-OFFICE



Designed & Made in
Centre For System Design
NITK, SURATHKAL

VidhYug series is another feather on the CSD's projects in the Electric Vehicle domain. VidhYug 2.0 which is being used by the RE office of NITK Surathkal has been successfully logging 1500 kms/month around the campus from the past 8 months. VidhYug 2.0 has been playing a major role in easing the landscaping, gardening related jobs of the RE office; in particular of the garden supervisor. This inhouse developed scooter has a light frame that makes it perfect to maneuver through NITK campus. The utility boxes are rust-proof and also water resistant. It is powered by Brushless DC (BLDC) motors. These motors possess a high torque density and superior efficiency.



SCAN ME

VidhYug 2.2 Series

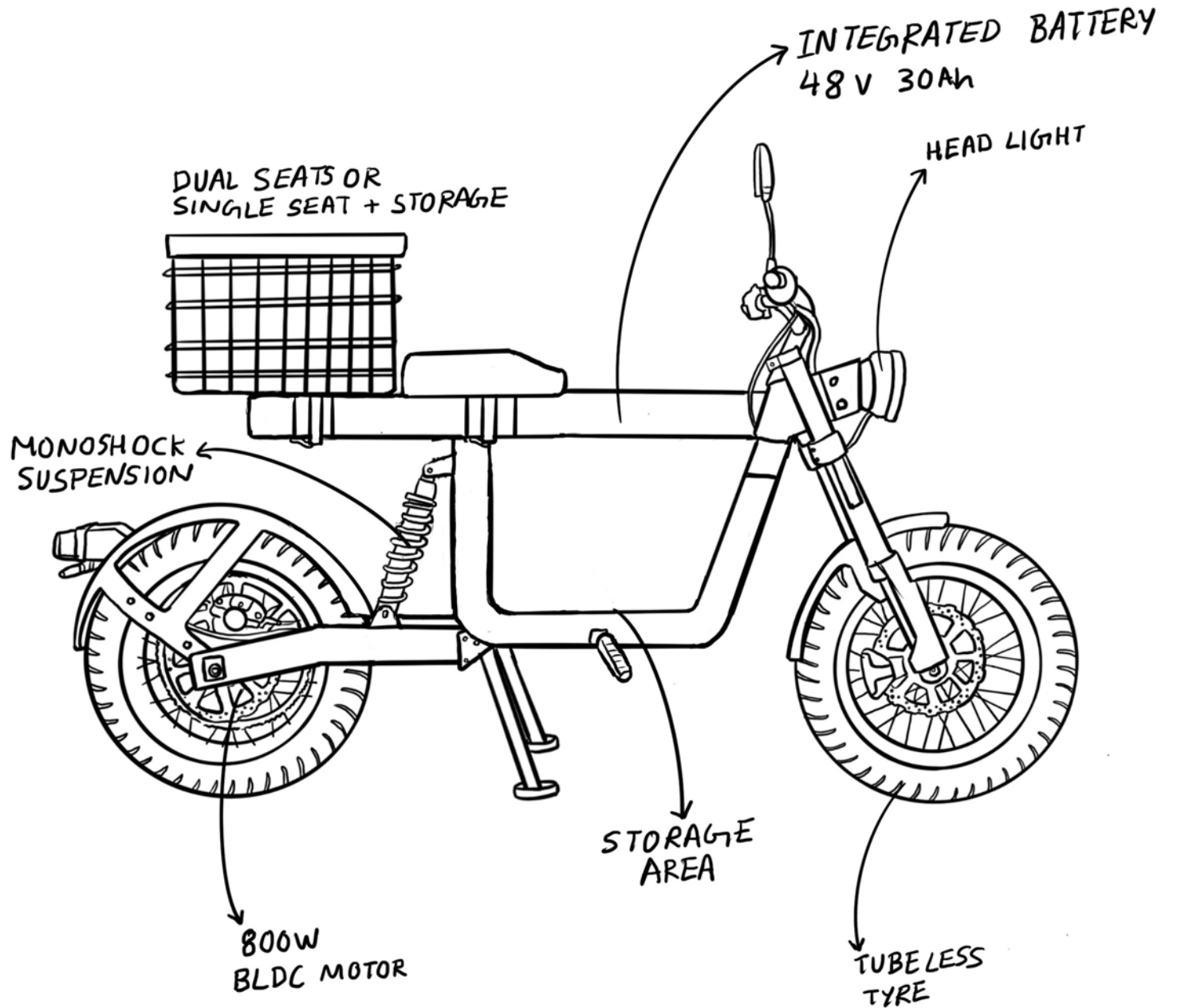
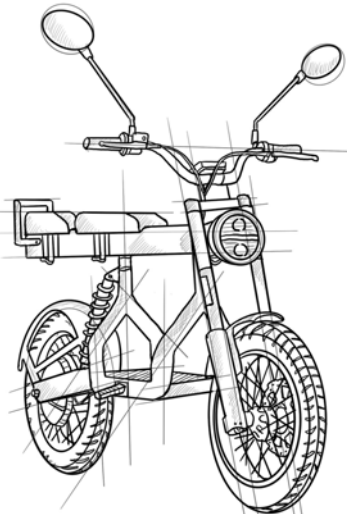
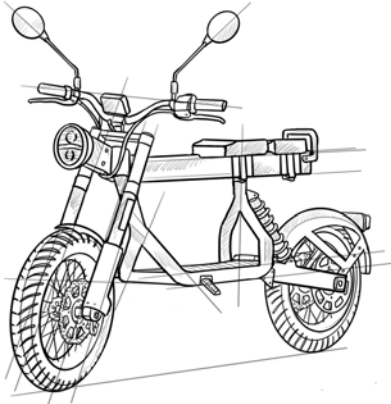
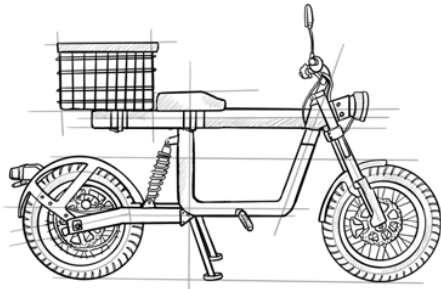

VidhYug 2.2.1

ELECTRICAL ENGINEERS

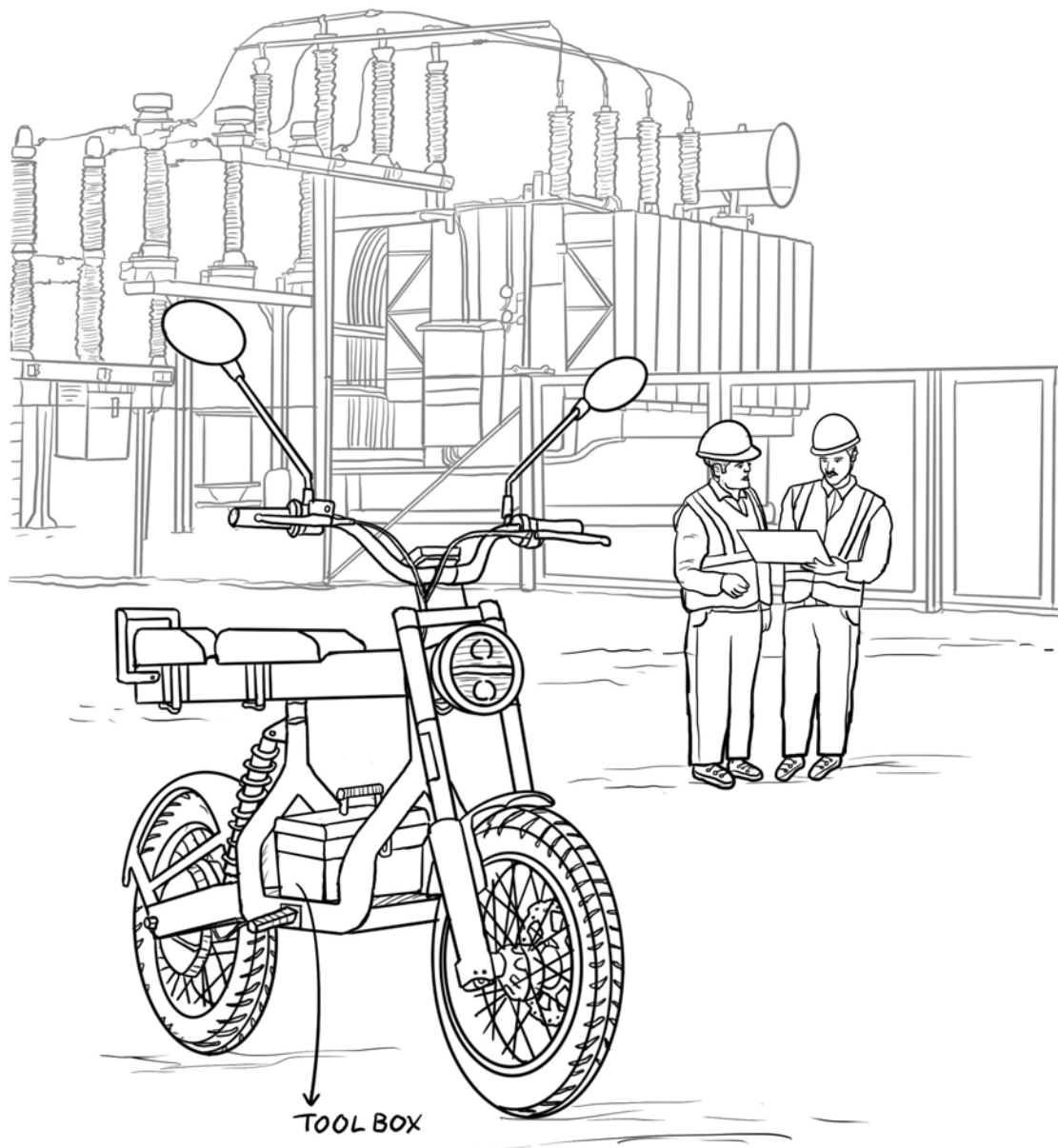

Conduct site visits, supervise the on-going works, attend & solve emergency or even non-priority based complaints around the campus.





VidhYug 2.2.2

CIVIL ENGINEERS

Site inspections of building constructions, supervise the on-going civil works, attend & resolve civil works related issues.



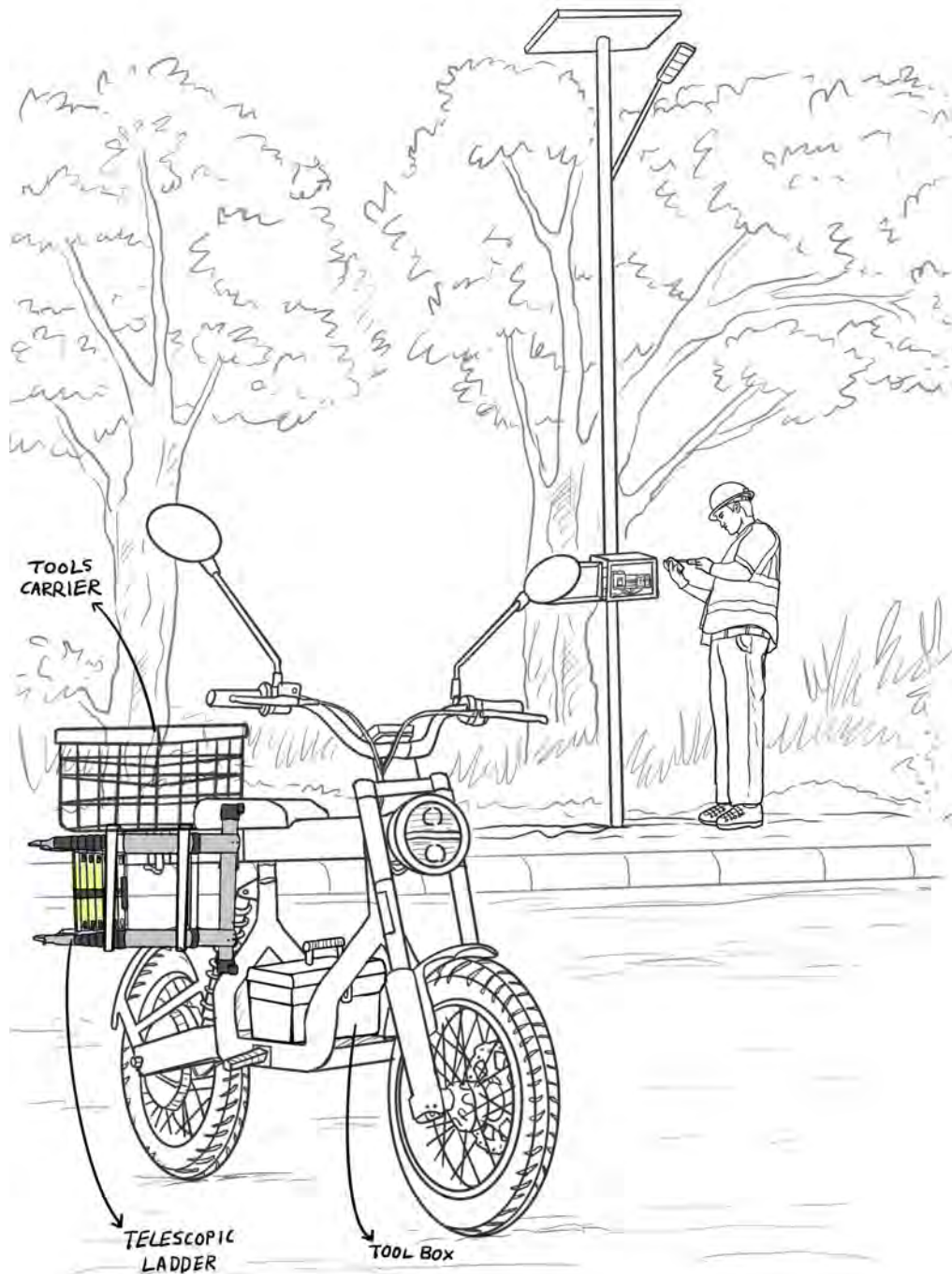

VidhYug 2.2.3

POWER HOUSE TECHNICIANS

Monitoring various power house related works, attend emergency issues, switching ON & OFF street lights in the campus.



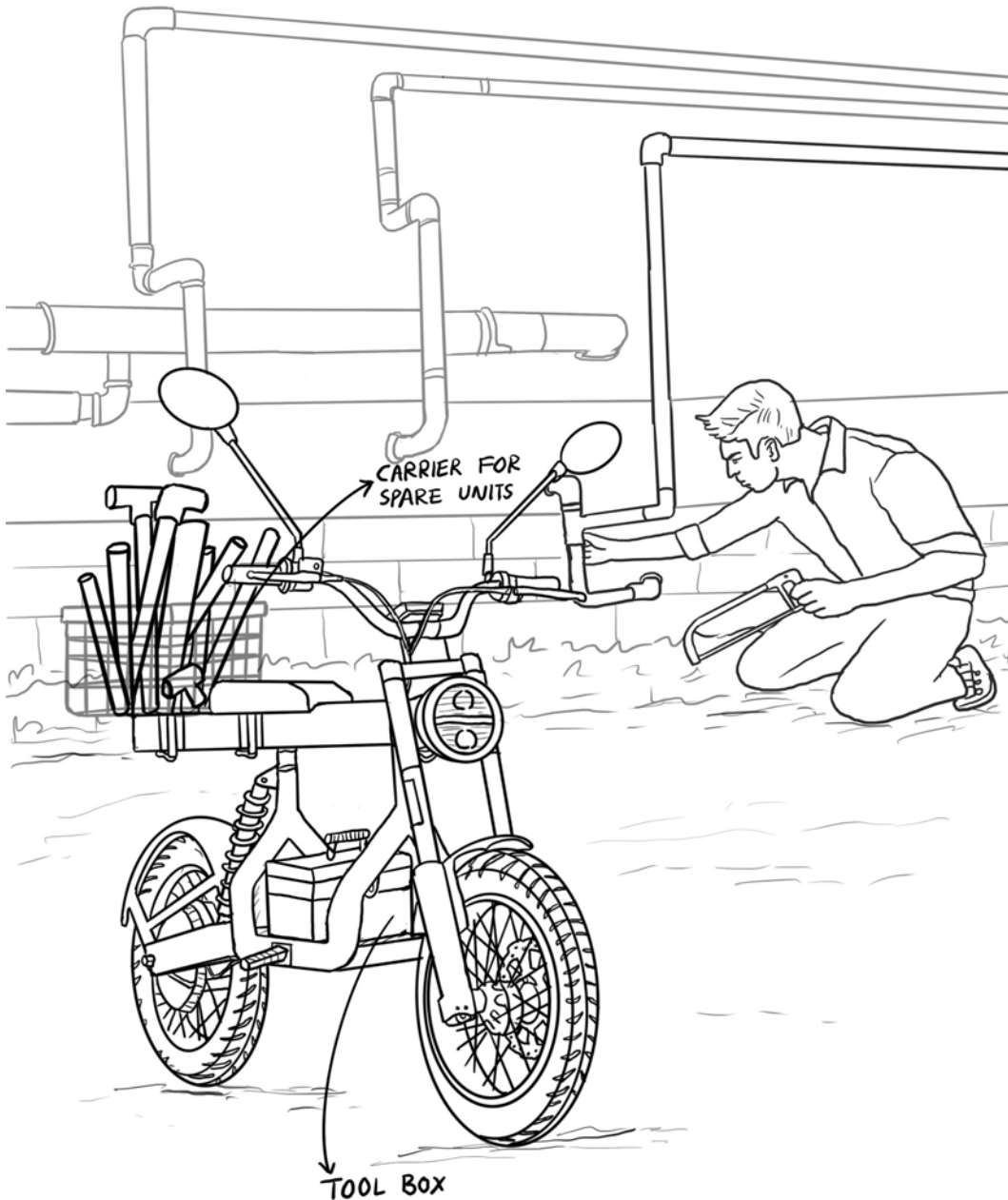

VidhYug 2.2.4

PUMP OPERATORS

Operate the pump at appropriate hours, perform gate valuation works, monitor over-head tanks, sump tanks, open wells & borewells.



CONCEPT DIAGRAM

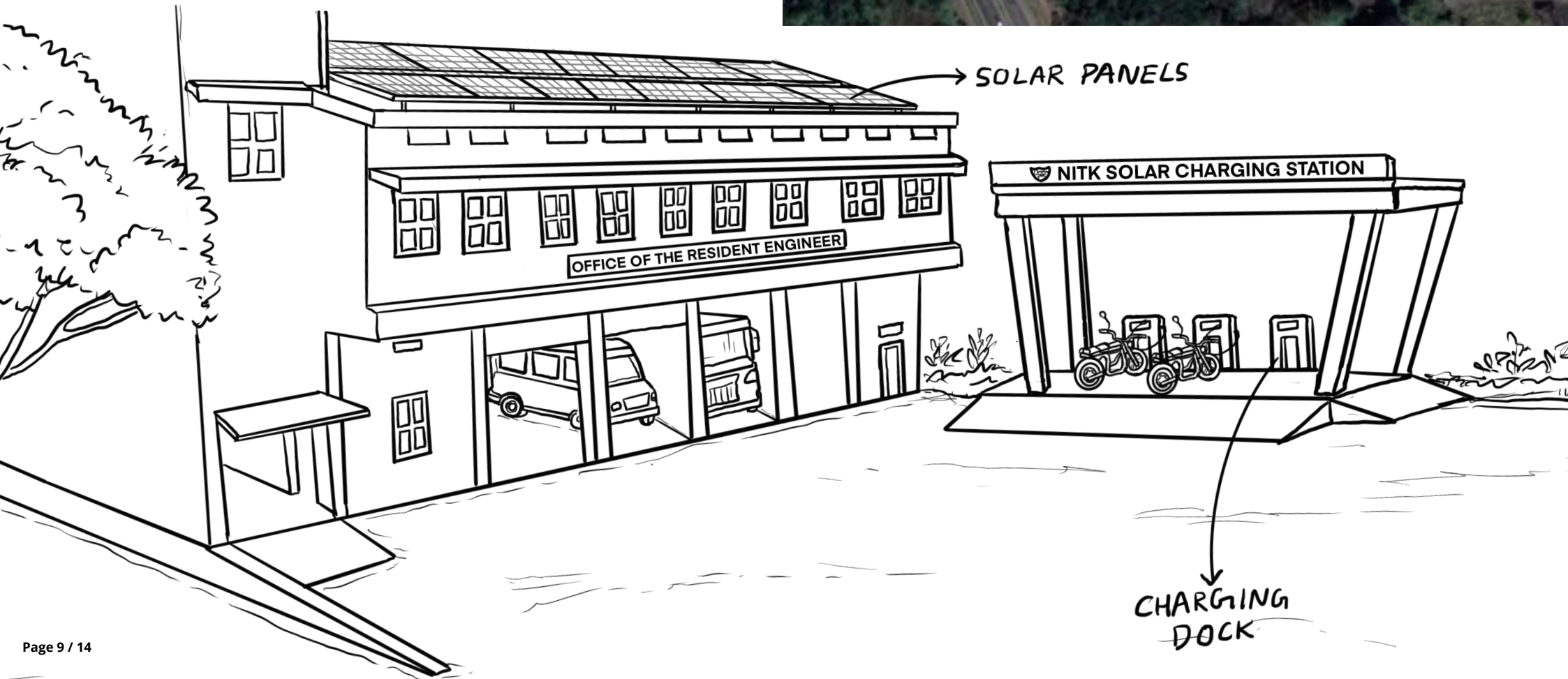

E - MOBILITY ECO SYSTEM

EXPERIENTIAL LEARNING

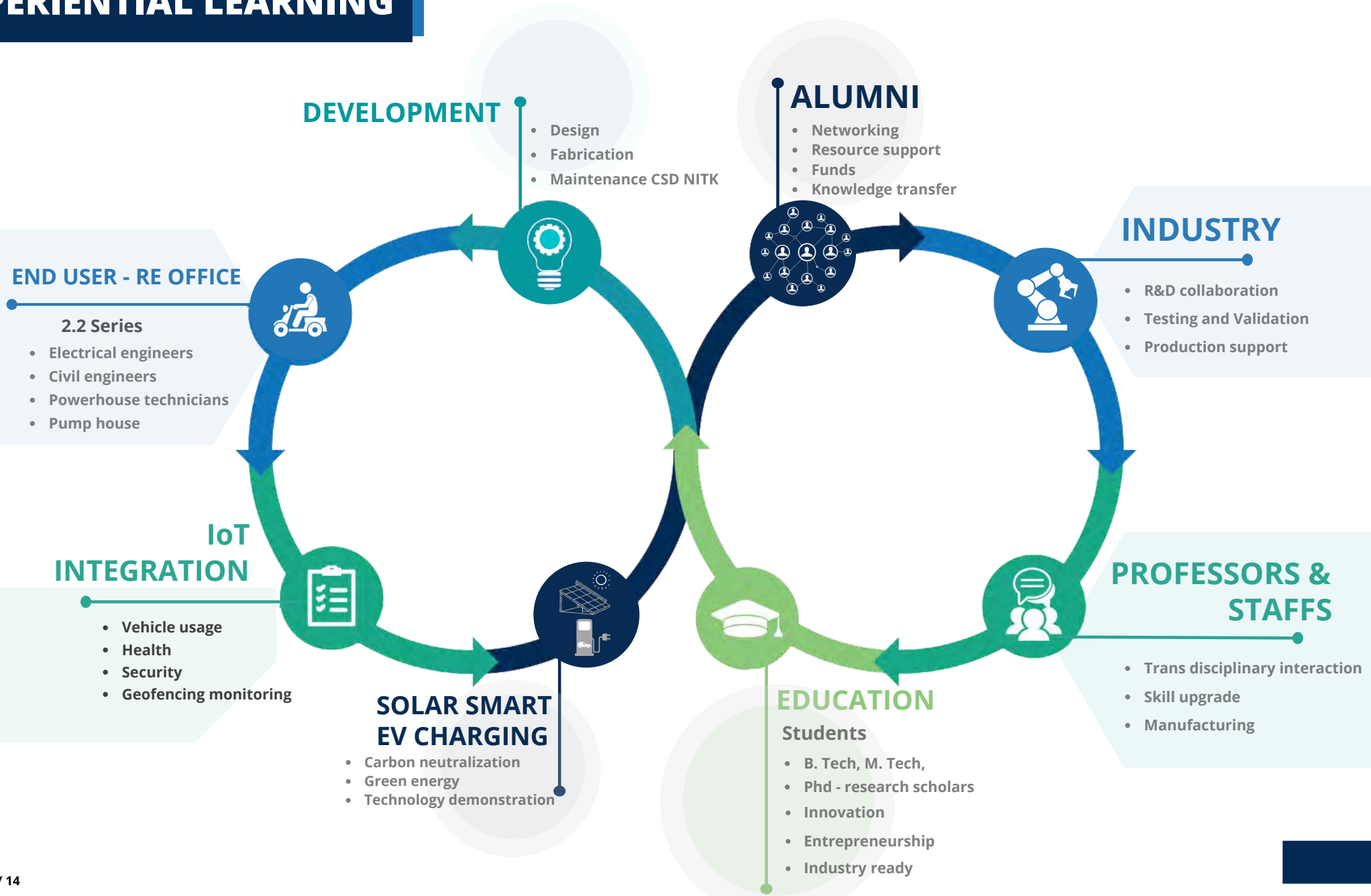

FACULTY INVOLVED



Dr. Pruthviraj Umesh
CSD'S E-Mobility Head
Assistant Professor, WR&OE Coordinator
NITK Surathkal



Prof. K.V. Gangadharan
CSD'S Coordinator
Professor, Mechanical Engineering
NITK Surathkal



Dr. Mohit P. Tahliliani
IoT Integrator
Assistant Professor, Computer Science and Engineering
NITK Surathkal



Prof. Umamaheshwar Rao
Director
NITK Surathkal



Prof. Vijay H. Desai
Dean AAIR
NITK Surathkal



Representative 1
Mumbai Chapter
NITK Alumni Association



Representative 2
Mumbai Chapter
NITK Alumni Association

STUDENTS CORE TEAM

Mr. Rakshith Kotian, MTech (R), JRF
Mr. Steevan Loyd, MTech (R), JRF
Mr. Rajath C Kotekar, MTech (R), JRF
Mr. Anarkala Ramakanth, PhD Research Scholar
Mrs. Anuradha S, SRF, PhD Research Scholar
Mr. Latheesh Shetty, JRF
Mr. Sandesh Bhaktha, SRF, PhD Research Scholar

Mrs. Shradha Shetty V, SRF
Mr. Suveen Poojary, JRF (Editor)
Mr. Sachin Shetty, Project Documenter
Mr. Sandeep V Suvarna, Project Documenter
Mr. Sarvesh Naik, Project Documenter
Mr. Shibi Manohar, Illustrator
Mrs. Jyothi S, Project Assistant
Mrs. Jyashree Arun Kumar, Technical Assistant

&

100+ B-Tech & M-Tech Students involved in design and development of E - mobility

BUDGETARY REQUIREMENTS

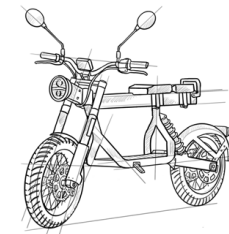
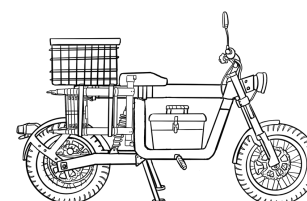
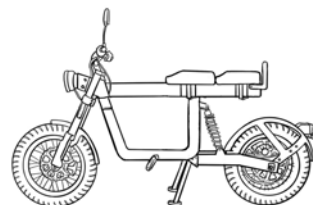
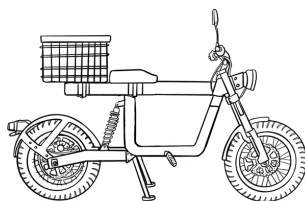

4 for RE Office Requirement + 1 for further R&D : ₹ 3,00,000/-
(₹60,000 x 5)

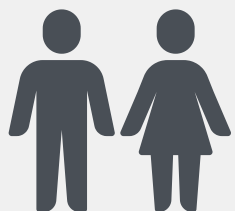

Man power for 3 years : ₹ 9,00,000/-
One Junior Research Fellow (JRF) ₹ 25,000/- per month

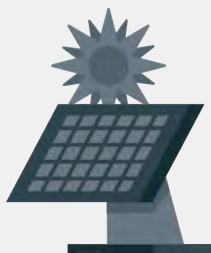

Solar E-charge Station : ₹ 9,00,000/-
(10 kW 8 Hours Backup, metal fabrication)

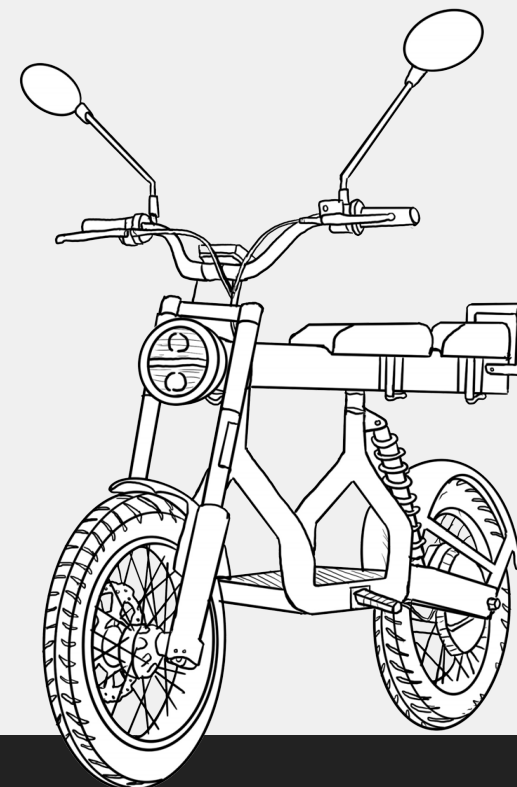

Total : ₹ 21,00,000/-

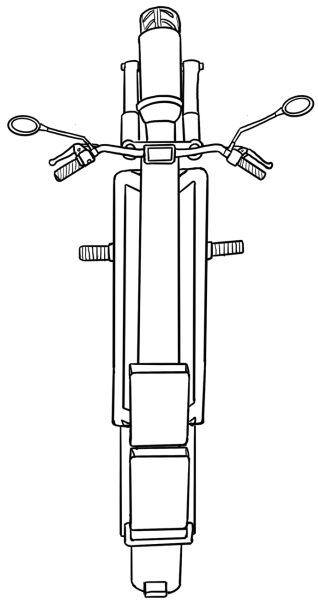

(i) Top View

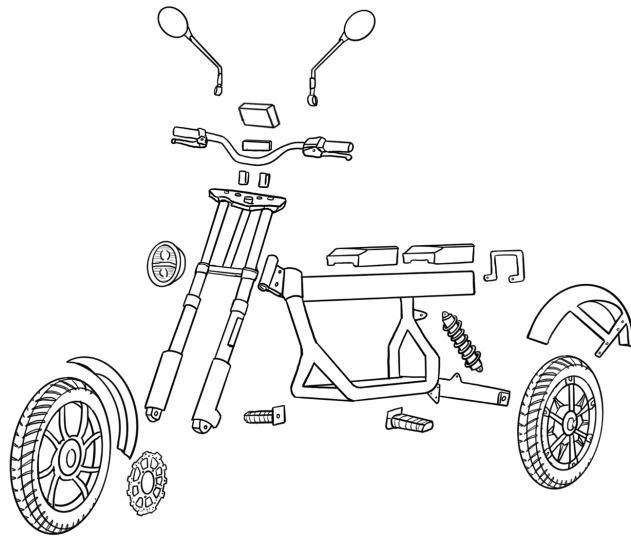

(ii) Exploded View

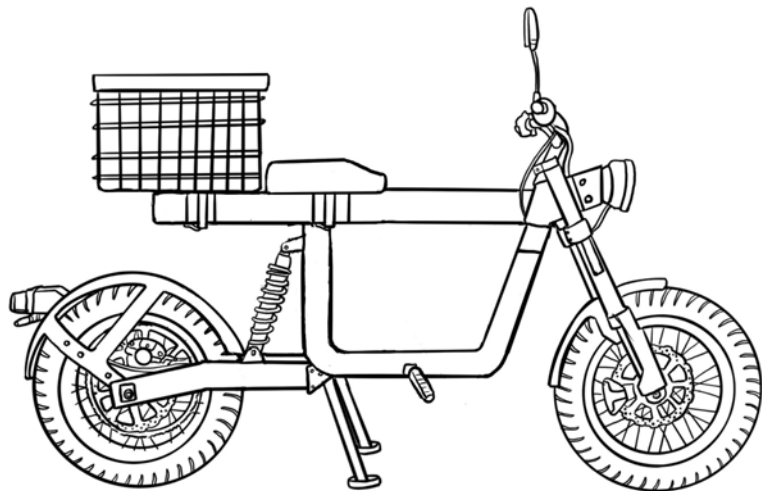

(iii) Side View

To meet the Resident Engineer - RE office requirements, CSD, NITK Surathkal has proposed to design, develop and handover VidhYug 2.2 series e-scooters; with 250W BLDC motor, 48V battery and gives about 60kms with the top speed of 25kmph and nominal charging time of 3-4hrs. Furthermore, the BLDC motor will be replaced with Switched Reluctance Motors (SRMs) to eradicate the dependency on permanent magnets as well as increase efficiency. These e-scooters will also be enabled with smart solar charging stations based on IoT integration.

E - Mobility 2.2 series Eco - System Donation Transfer Details

Name of the Account Holder
NITK/KREC Endowment Fund

Account Number
37481178720

Name of the Bank
State Bank of India
Branch Surathkal, Mangalore

Address
Surathkal Branch, NITK Campus,
P.O.Srinivasanagar, Dakshina Kannada,
575025

IFSC Code
SBIN0002273



NATIONAL INSTITUTE OF TECHNOLOGY KARNATAKA, SURATHKAL
OFFICE OF THE RESIDENT ENGINEER
POST SRINIVASNAGAR, MANGALURU – 575025 (DK)

Phone : [0824] - 2474000, 2473028
E – mail: re.electrical@nitk.edu.in

Fax: [0824] 2474033
Website: <http://www.nitk.ac.in>

No: 50/MTC/REO/2021-22/AC1

Date:- 03/01/2022

To

The Director
NITK
Surathkal

Approved
4.1.22

Sir,

Sub :- Request to provide 4nos of E – scooters for office work purpose - reg.

With reference to the above subject I would like to state that, our office is one of the important service units which plays a vital role in providing the requisite infrastructure facilities and all other amenities in the campus. This office is executing several infrastructure projects, all kinds of maintenance works in the campus, providing water supply and electricity facilities to the campus, gardening, waste water management etc. For monitoring of above works on regular basis, our office staffs using their personnel vehicles.

Hence, I request you to provide 4nos of electric scooters (E-Scooter) exclusively to this office for following work purpose.

- 1 no to Electrical engineers for site visit, attending emergency complaints, supervision of ongoing works etc.
- 1 no to Civil engineers for site visit, attending emergency complaints, supervision of ongoing works etc.
- 1 no to Technicians in Power house for different powerhouse monitoring work, attending emergency complaints, Switching ON / OFF of street lights in the campus etc.
- 1 no to pump operators in Pump house for Pump operation work, gate valve operation work, monitoring of over head tanks, sump tanks, open wells, borewells etc.

Kindly advise the **Chairman, Centre for System Design** to prepare 4nos of E scooters for work establishment section.

Yours faithfully,

Resident Engineer